

 CITTERIO



Sealed/

Design by/ F. Mirezzi & V.Parigi

Partitions

PLUS

GLAZED OR BLIND
PARTITION WITH
VERTICAL
OR HORIZONTAL
UPRIGHT

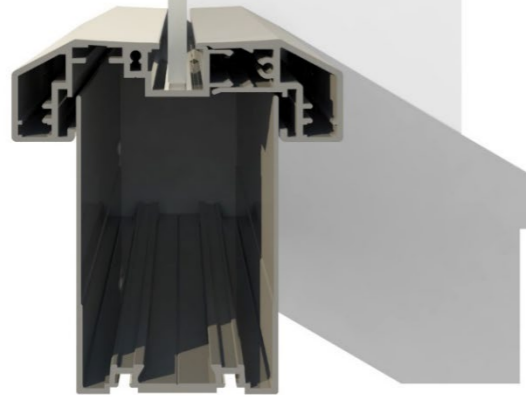

SINGLE GLAZED
PARTITION



DOUBLE GLAZED
PARTITION
EXTERNAL PROFILE



DOUBLE FRAMED
GLAZED
PARTITION



BLIND
PARTITION

PLUS



- STRUCTURAL PROFILE IN **STEEL SHEET**
- THICKNESS **105 mm**
- **VERTICAL** OR **HORIZONTAL BANDS PARTITION**
- **3 VERSIONS** OF GLAZED PARTITION
- THICKNESS OF **BLIND PARTITION 20 mm**, COVERED WITH LAMINATE MELAMINE, VENEER OR LACQUERED
- **THICKNESS OF GLASS 6 mm**
- **SWIVELING** ALUMINIUM BLINDS
- **ONLY GLASS** OR **FRAMED DOOR**
- SWING **DOORS** FOR **SOLID WALL**
- SINGLE OR DOUBLE GLAZED **SWING DOOR**
- BLIND **SWING DOORS**
- SINGLE GLAZED OR BLIND **SLIDING DOORS**
- SINGLE OR DOUBLE LEAF **DOORS**
- **EXTERNAL** OR **INNER PROFILE SLIDING DOOR**

STEEL SHEETS PROFILE



THICKNESS OF GLASS

6 mm



90° METAL
CORNER



SWING DOORS



SWING DOORS

DETAIL PIVOT HINGE



SLIDING DOORS





TECHNICAL SHEETS

DOUBLE GLAZED PARTITION DETAIL

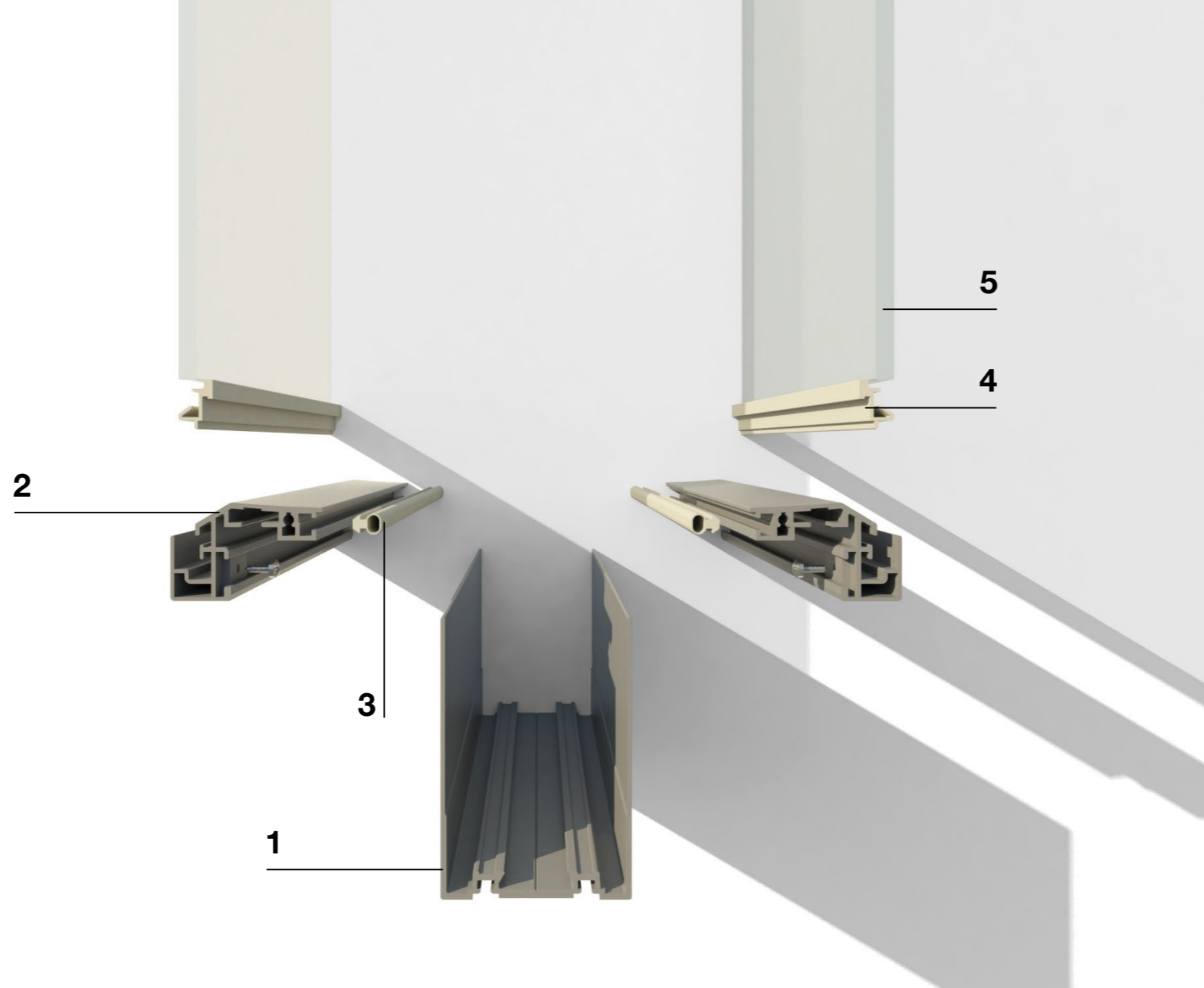

1. LOWER RAIL
2. STOP FOR GLASS PROFILE
3. GASKET
4. GASKET
5. LAMINATE GLASS

SINGLE GLAZED

PARTITION

_D105xH112 mm

THICKNESS OF GLASS

6 mm



DOUBLE GLAZED

PARTITION

_D105xH112 mm

THICKNESS OF GLASS

6 mm

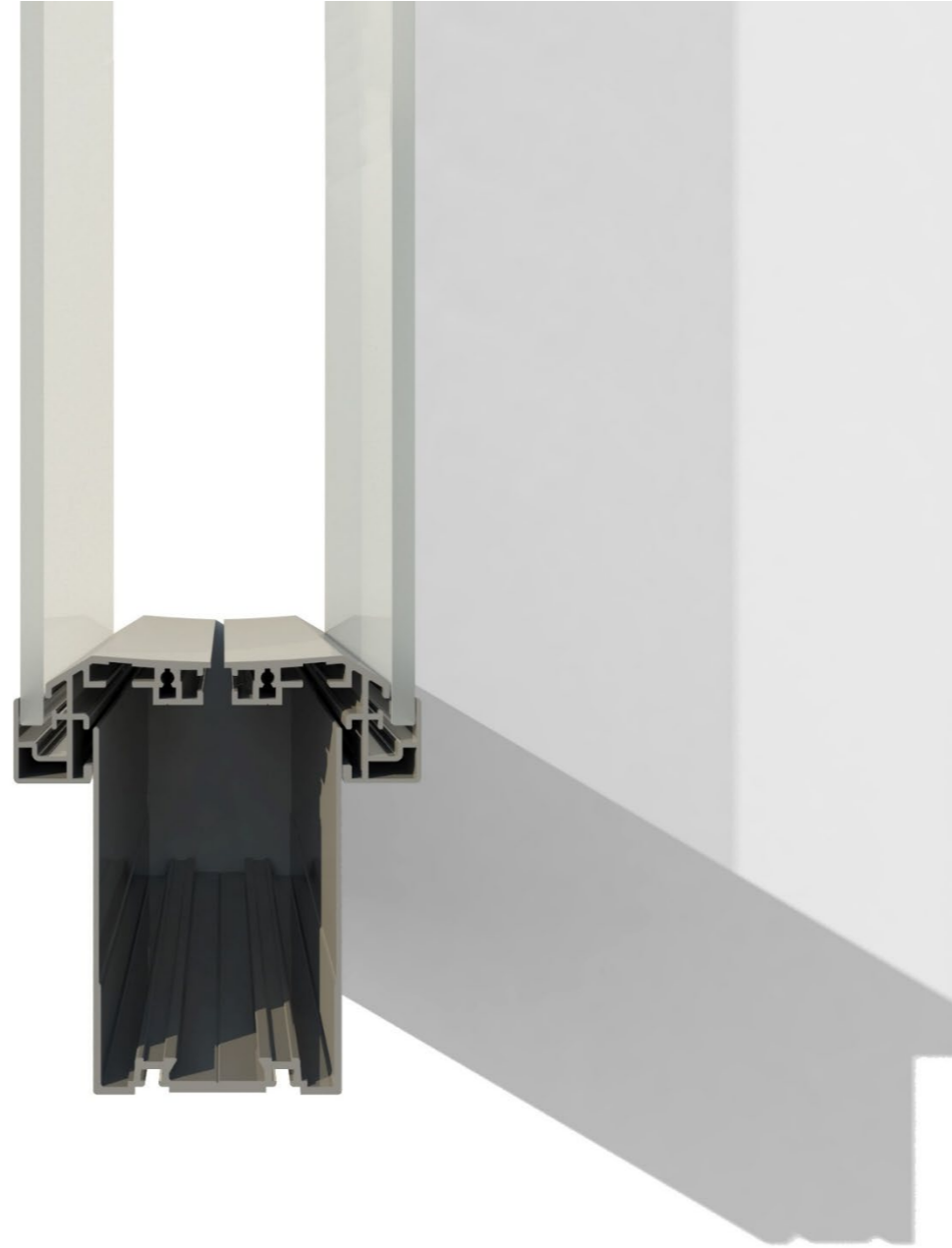

DOUBLE GLAZED

PARTITION

_D105xH112 mm

THICKNESS OF GLASS

6 mm

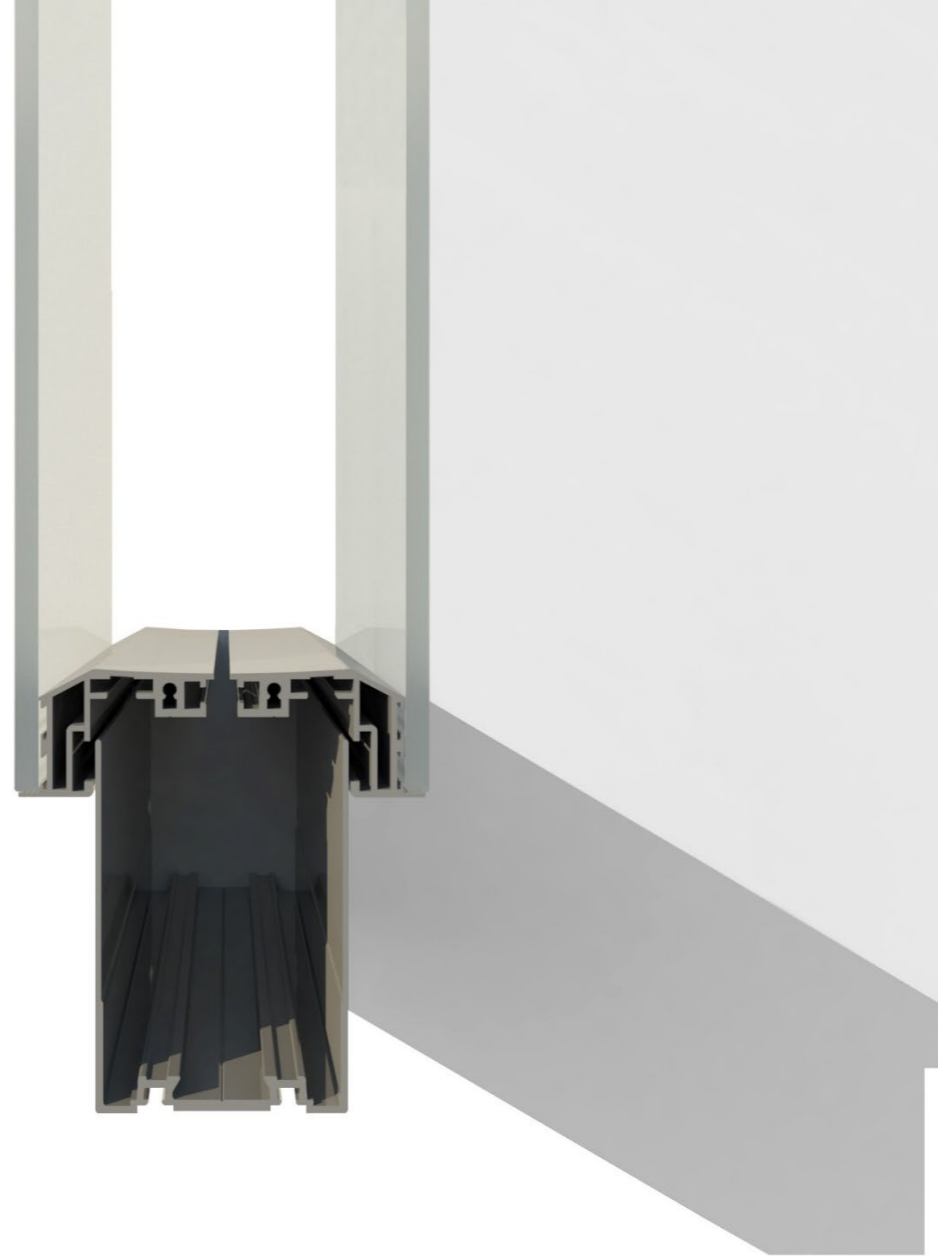

BLIND

PARTITION

_D105xH112 mm

THICKNESS OF THE PANEL

20 mm

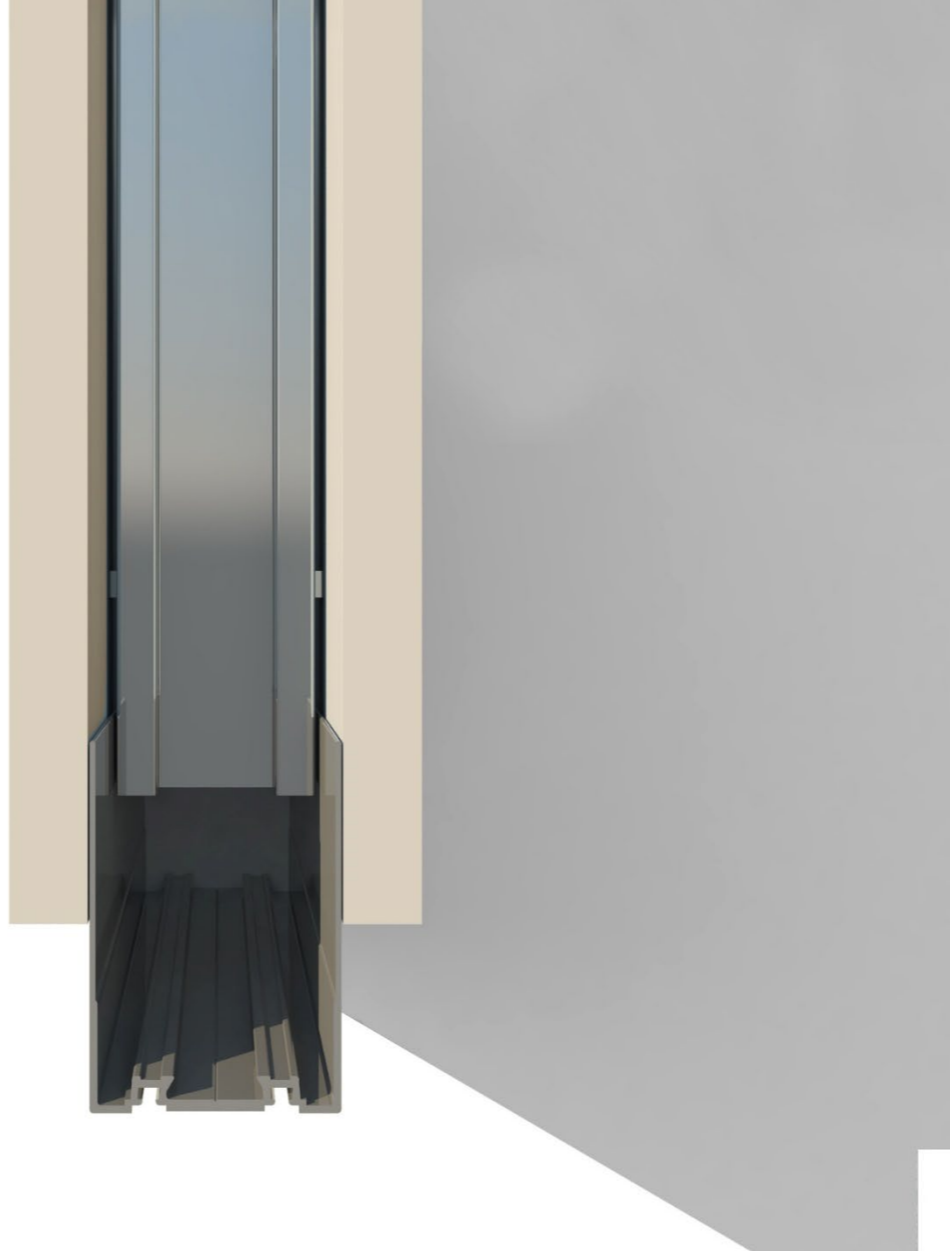

STARTING
PROFILES
FROM **SOLID WALL**

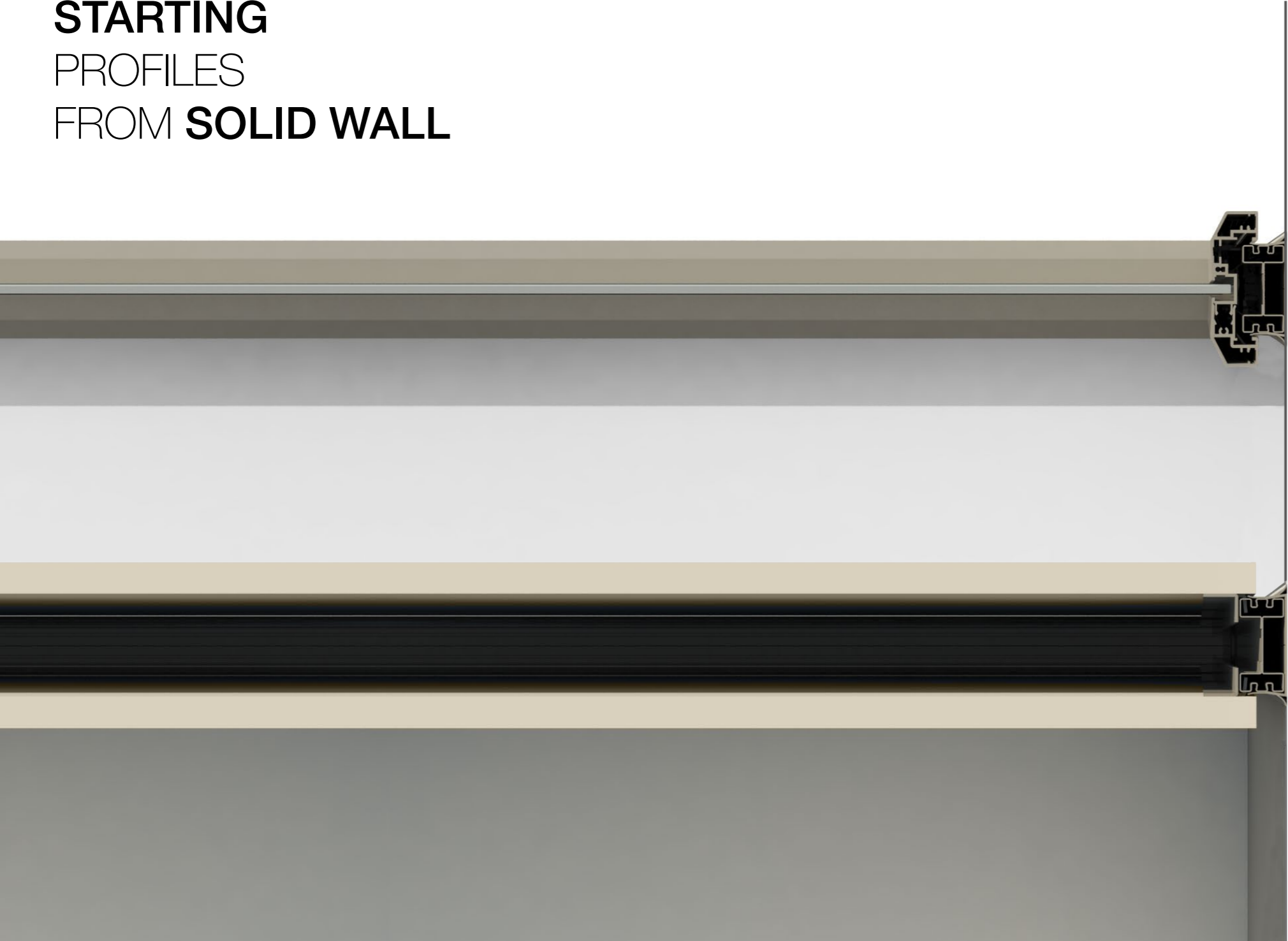

STARTING
PROFILES
FROM **SOLID WALL**



CONNECTION PROFILE BETWEEN CABINET AND GLAZED PARTITION

RECESSED



CONNECTION PROFILE

BETWEEN CABINET
AND BLIND PARTITION

RECESSED



CONNECTION PROFILE

BETWEEN CABINET
AND BLIND PARTITION

RECESSED

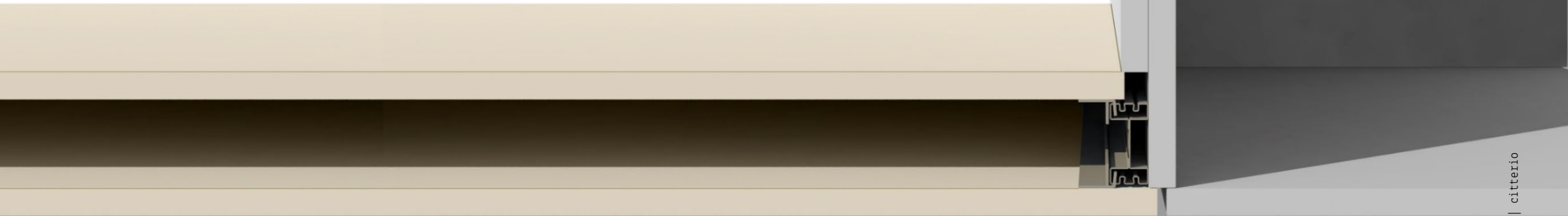

GLASS TO GLASS CONNECTION

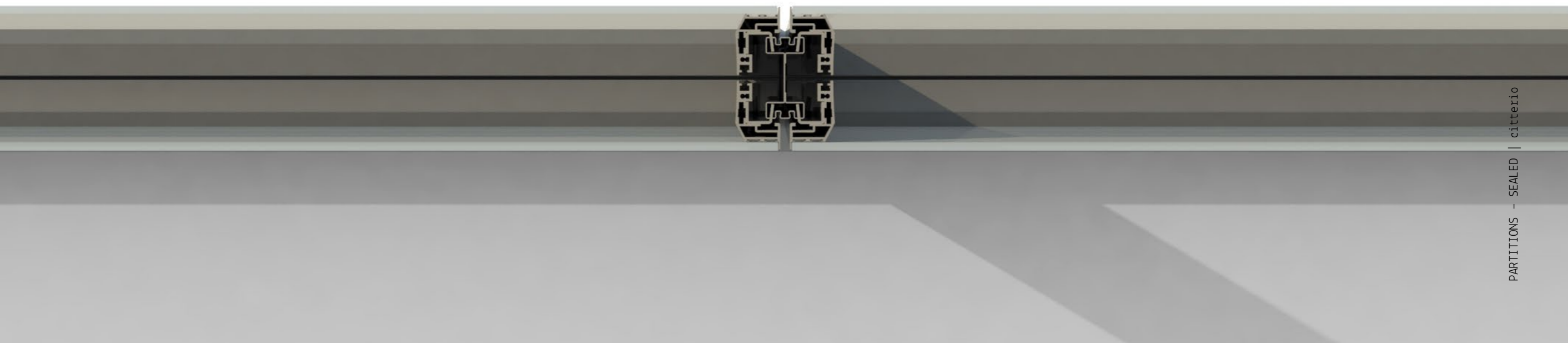

CHANGE IN THE
STRUCTURE
DOUBLE GLASS TO SINGLE GLASS



CHANGE IN THE
STRUCTURE
GLASS TO WOOD

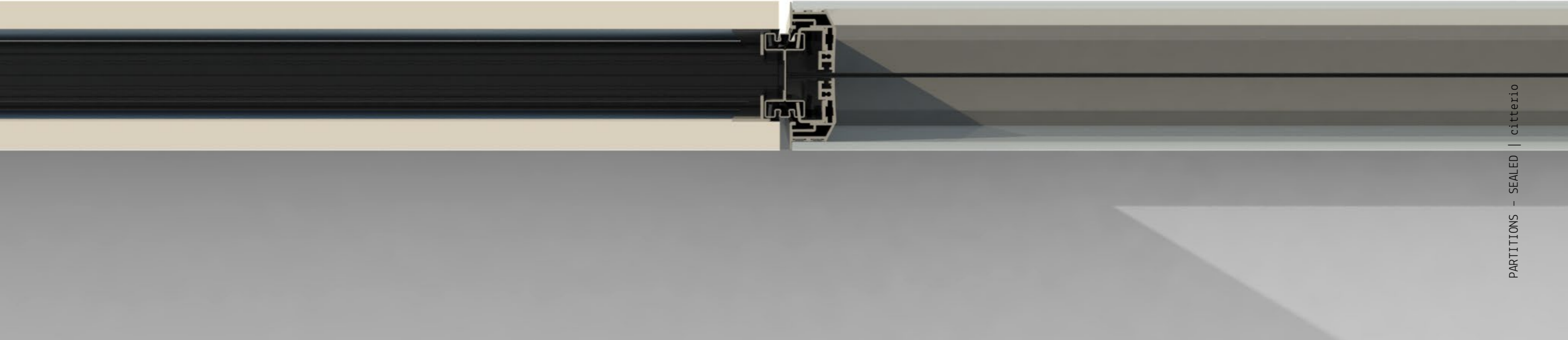

90° WOOD CORNER
CHANGE IN THE
STRUCTURE
GLASS TO WOOD



90° METAL CORNER
CHANGE IN THE
STRUCTURE
GLASS TO WOOD



VARIABLE ALUMINIUM CORNER



FROM 90°
TO 135°

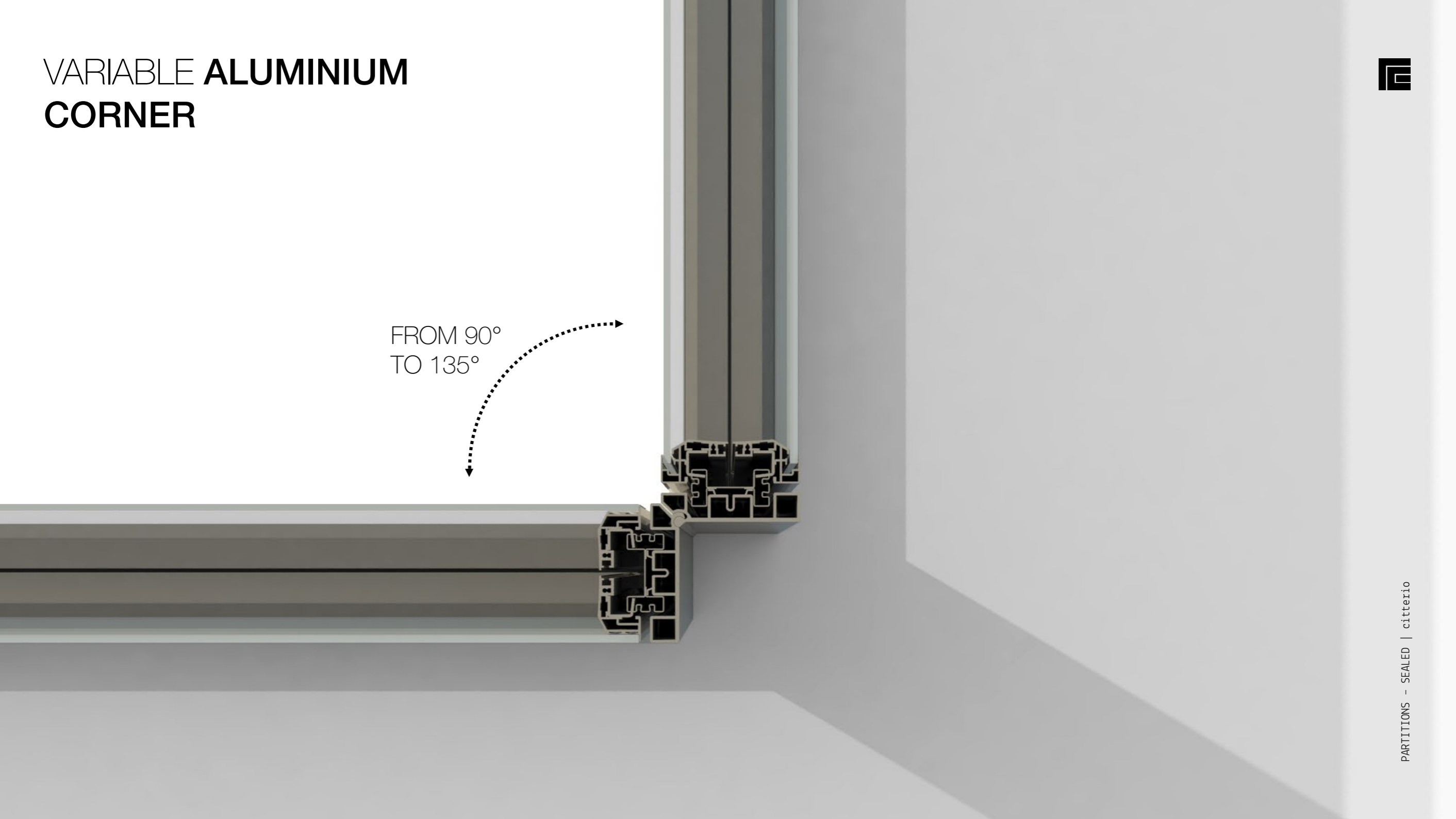
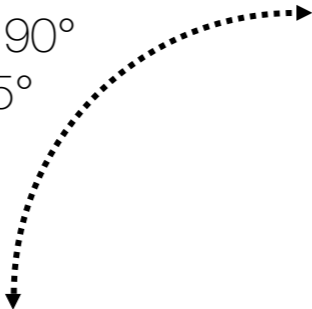

135° WOOD CORNER
CHANGE IN THE
STRUCTURE
GLASS TO WOOD

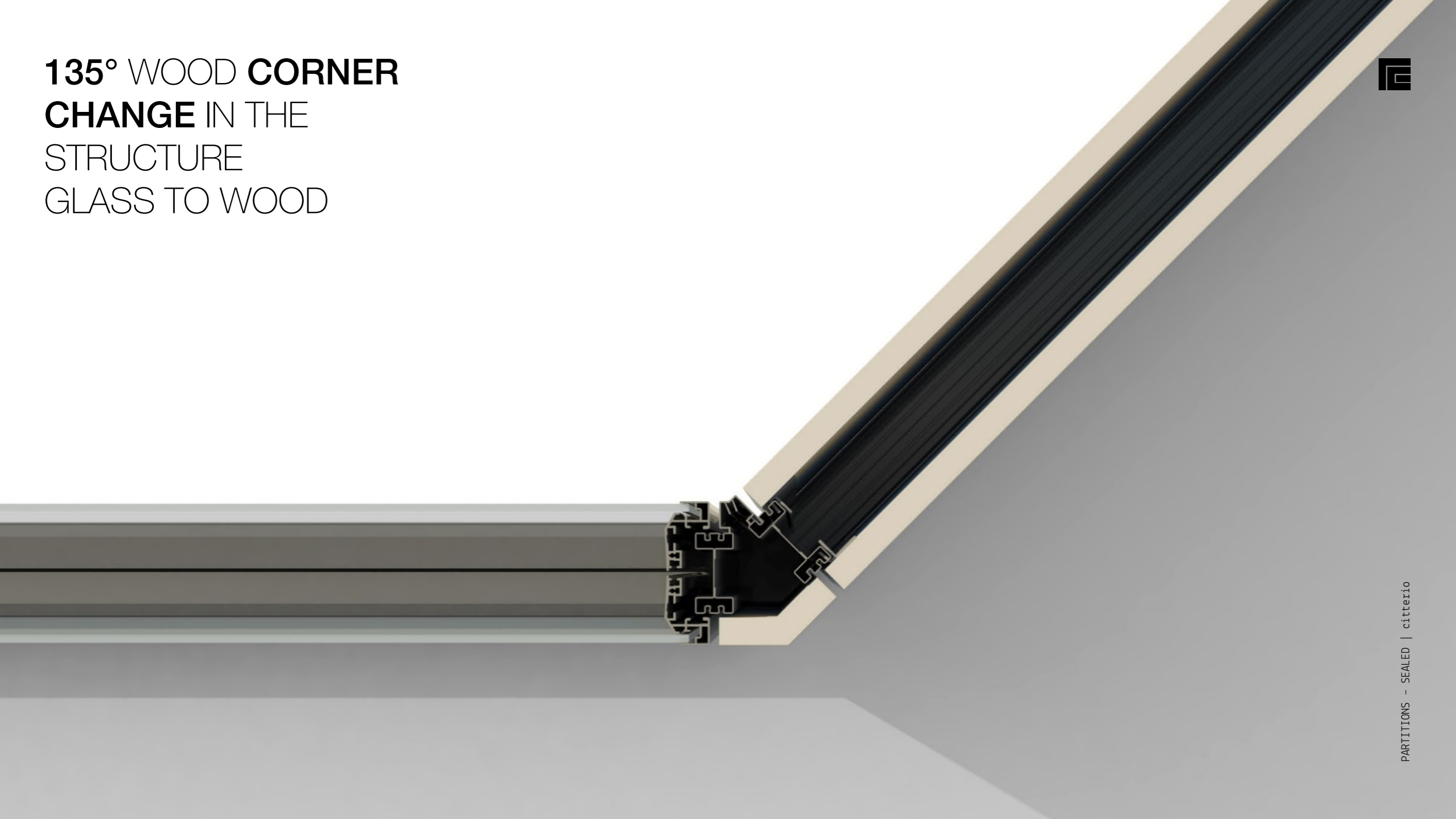

135° METAL CORNER
CHANGE IN THE
STRUCTURE
GLASS TO WOOD

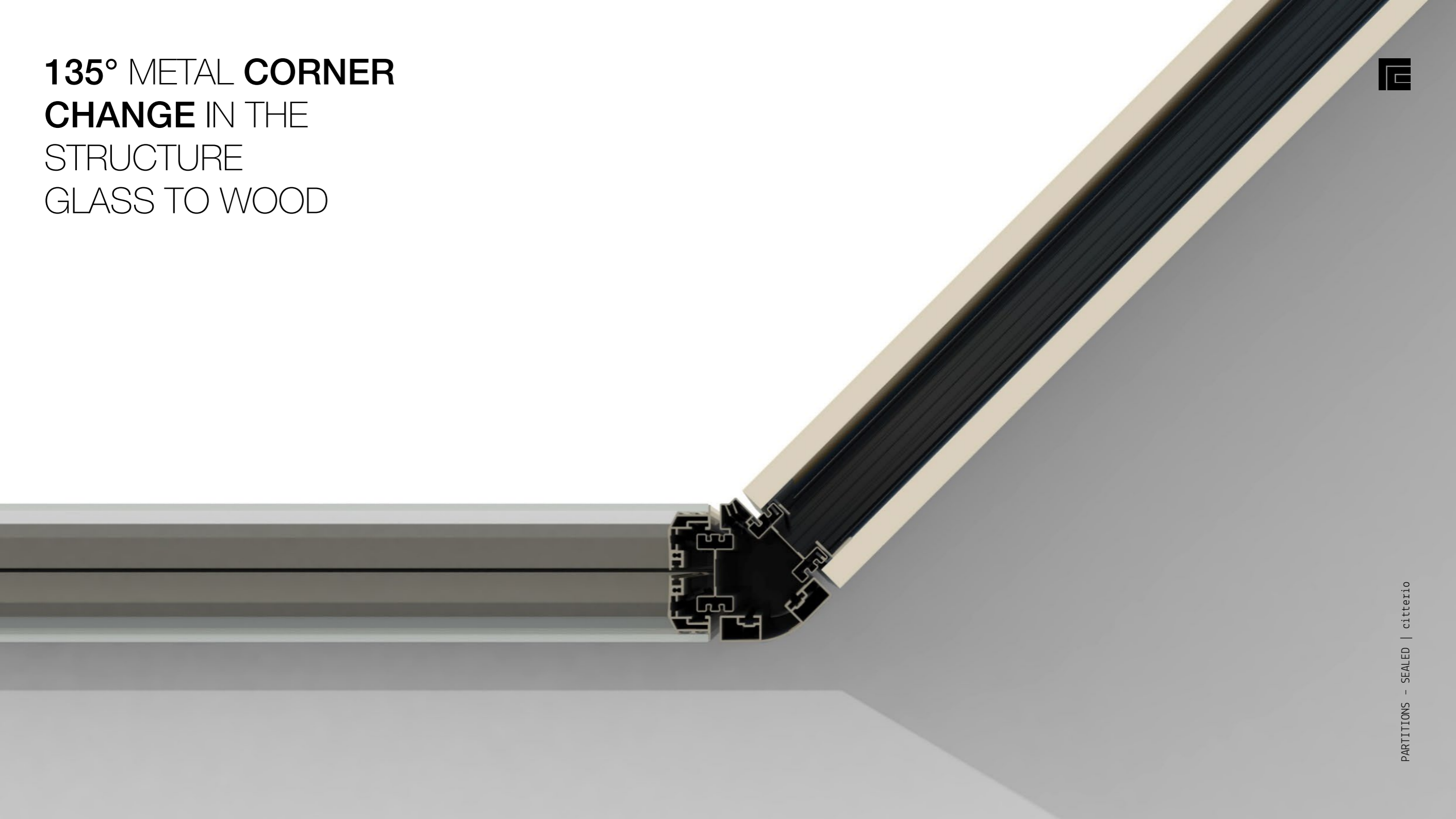

THREE WAYS JOINT
CHANGE IN THE
STRUCTURE
GLASS TO WOOD



ENDING PROFILES

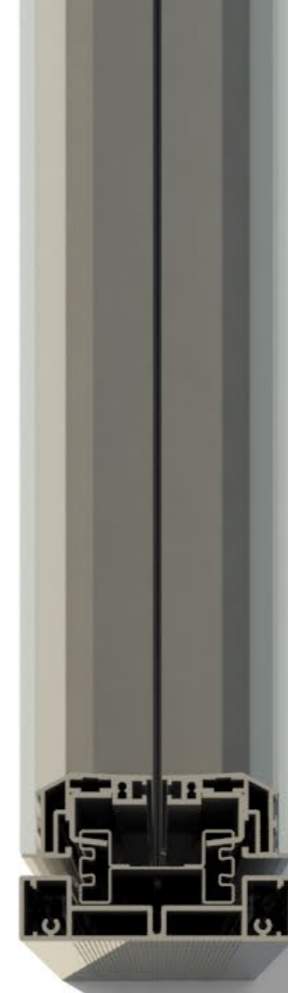
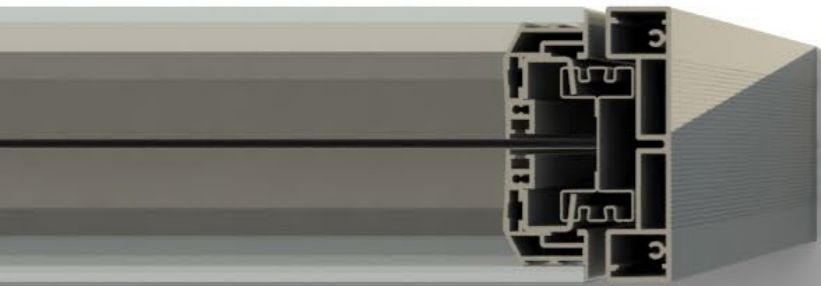

ENDING PROFILES

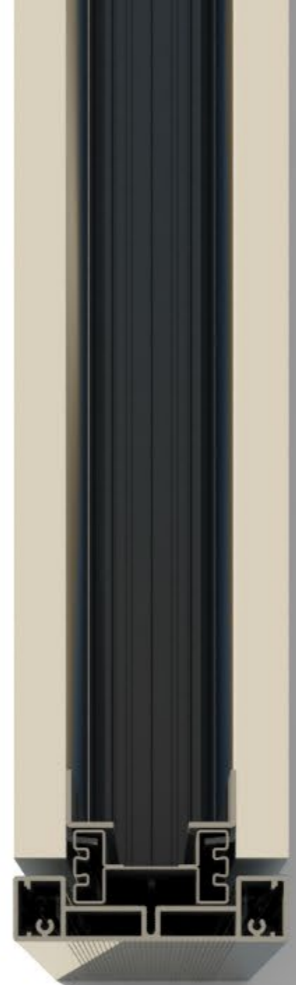
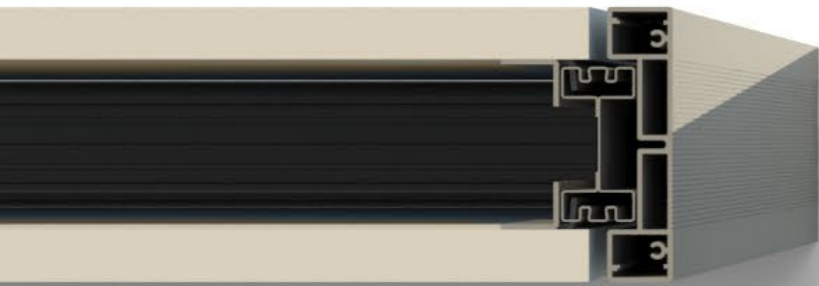

SINGLE GLAZED SWING DOORS

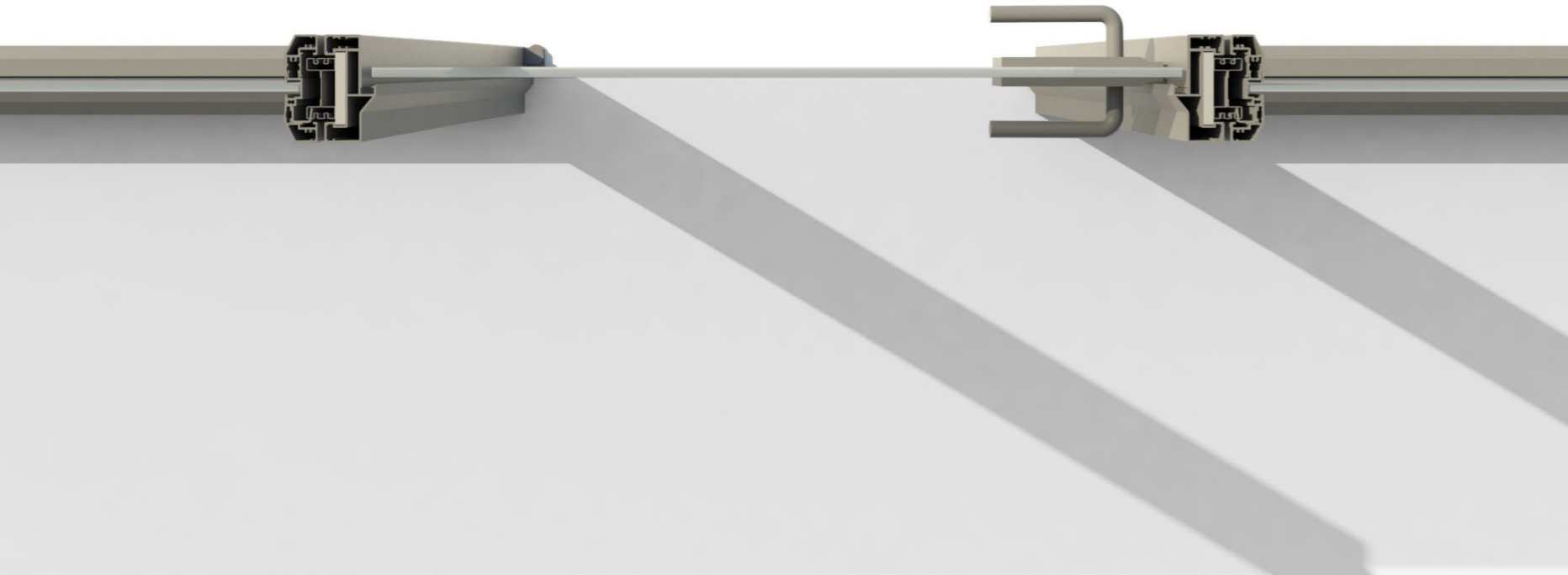
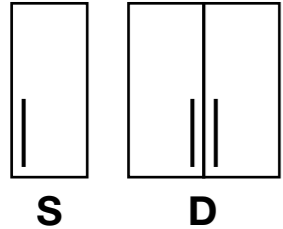

DOUBLE GLAZED SWING DOORS

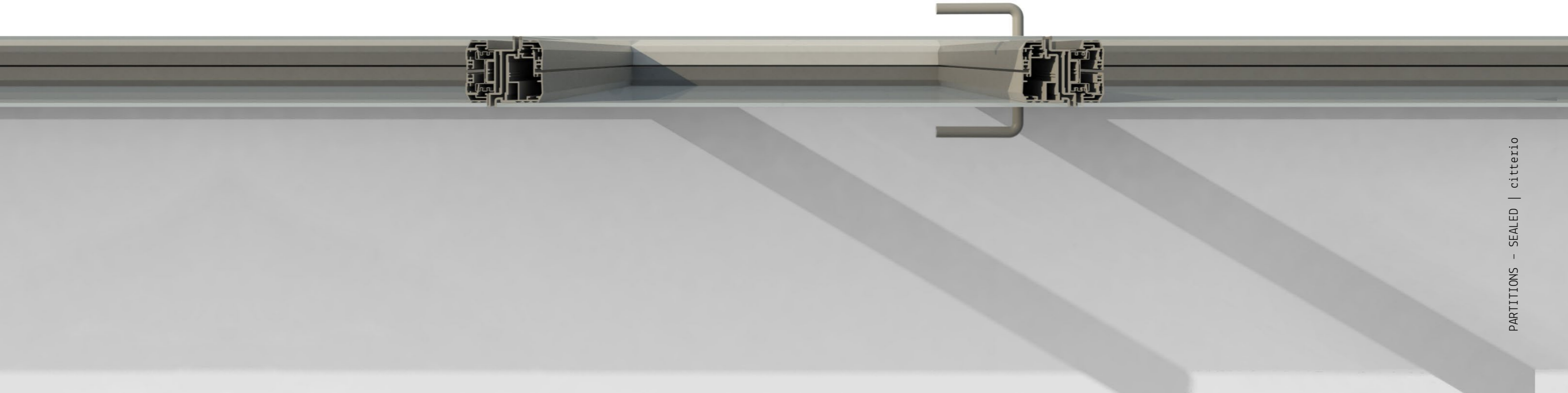
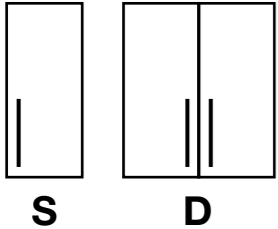

BLIND SWING DOORS

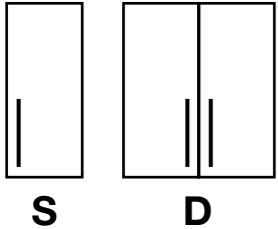

SINGLE GLAZED SLIDING DOORS

INSIDE / OUTSIDE

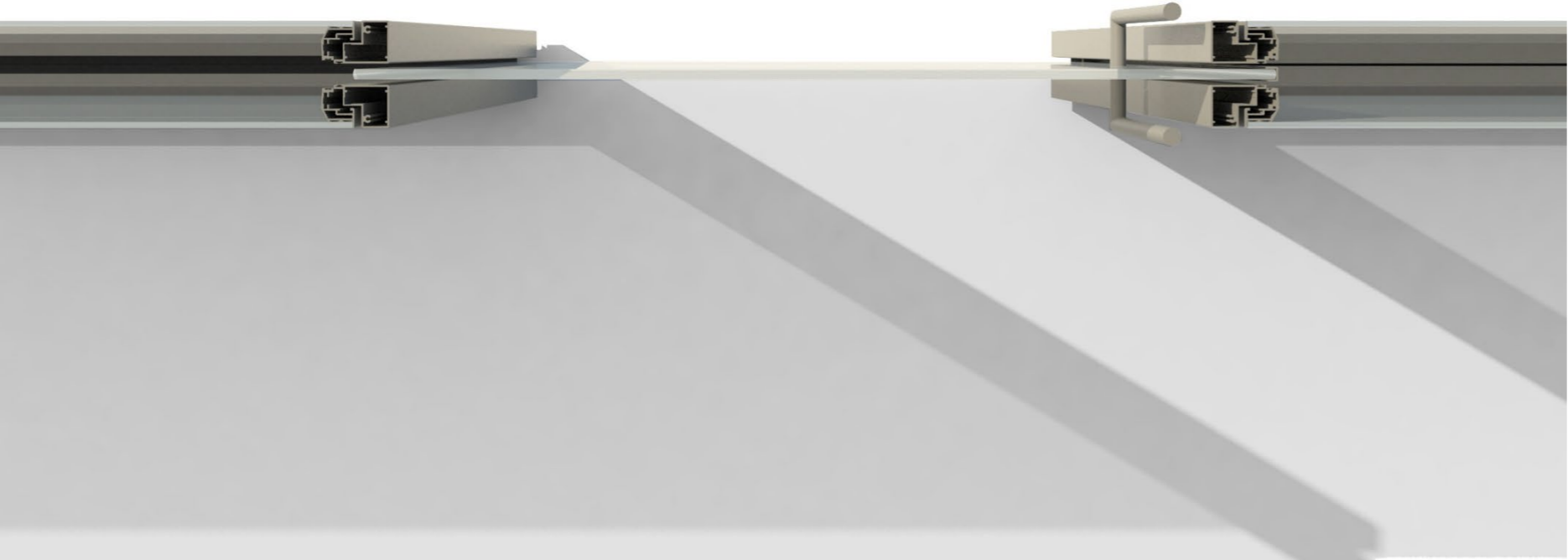
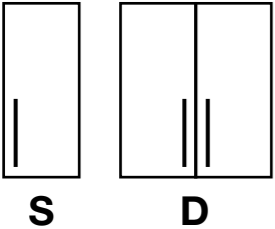

BLIND SLIDING DOORS

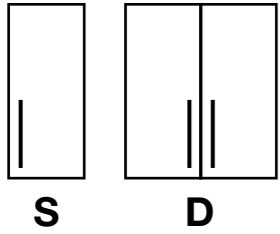



FINISHES



Melamine



M69
Ice white

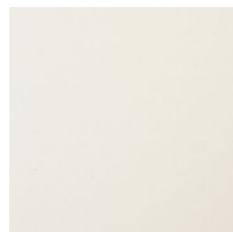

M68
Pure white

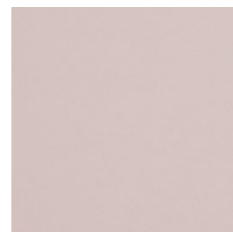

M70
Scroll grey

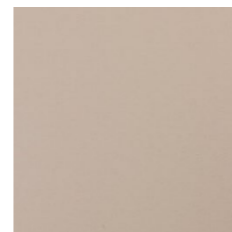

M66
Line grey



M67
Carbon grey

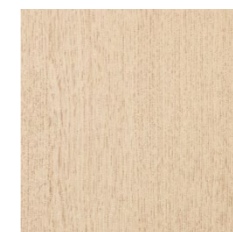

N60
Light oak

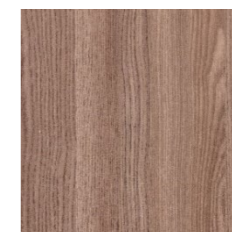

N62
Brown ash



N63
Titanium larix

Woods

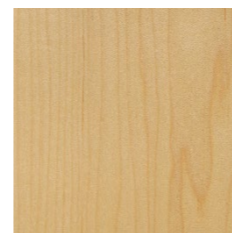

I46
Sycomore

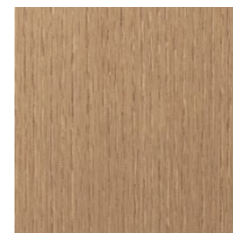

WIR 1
Brushed
natural oak

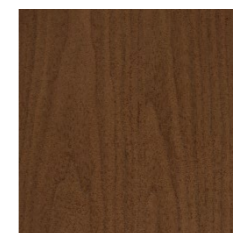

IA4
Canaletto walnut



IA5
Bronze
lacquered oak



WIR2
Brushed caffè oak



Metals



R9010
White



R9005
Black



A61
Natural aluminium



A86
Polished aluminium

Glasses



V1
Clear glass

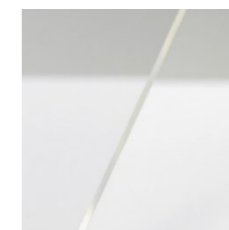

V2
Extra-clear glass



V3
Acid-etched glass

Films



P1
Acid-etched film



P2
Striped
acid-etched film



CITTERIO SPA

VIA DON GIUSEPPE BRAMBILLA 16/18
23844 SIRONE (LECCO) - ITALIA
T. +39.031.853545 | F. +39.031.853529 |
www.citteriospa.com | vendite@citteriospa.com

ISO 9001 and ISO 14001 certified company
FSC[®] License C141846 - Leed[®] Compliance